





Pentatonic Chimes – Set of 16, Surface Fix 23166



manufacturer instructions are included with the product when purchased – these are simply a summary

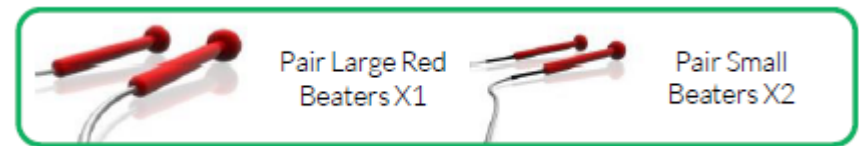

Components:

-  Eye Straps X3
-  M6x20mm Secure Screw X6
-  M8x40mm Secure Screw X10
-  M8 Lock Washer X10



-  2 Part Cover Cap x24
-  M10 Barrel Nut x3
-  M10x70 Security Screw x3



Before Installation

Choose a suitable location for the Chimes, bearing in mind the amount of space required around them. Install the Chimes with 1.5m free space (from widest point) around it:

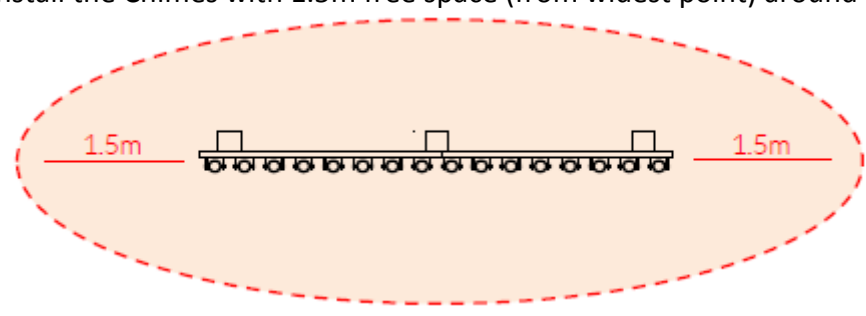

Bear in mind the product weight:
 Weight of heaviest part (left panel): 12kg
 Total weight: 25kg

Installation



1. Carefully lay 3 x legs on a level surface and check distance between each leg is equal. Join together the 2 parts of the symphony. Line up pre drilled holes in the backboards with the legs and ensure the instrument is aligned square with the legs. Fix in place using M8x40mm screws supplied (see installation guide)

2. Attach Surface Fixing posts to legs (See Surface Fix Post Installation Sheet)

3. Locate Instrument in desired location and mark holes to fix to desired surface.

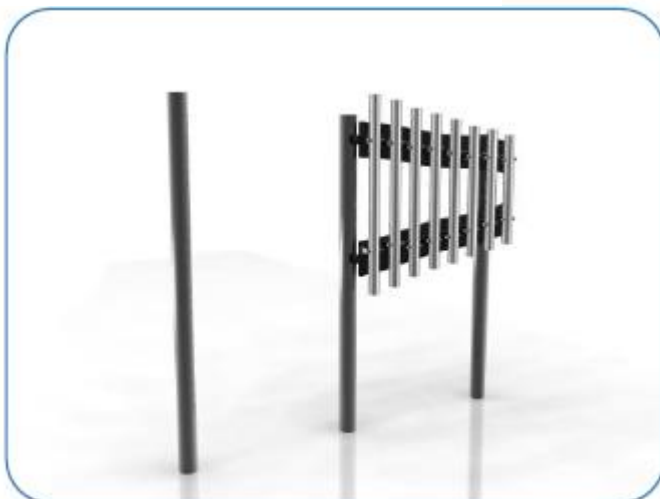

4. Fix Surface Plate to level surface using Coachscrews, Rawlbolts, chemical anchors or similar as deemed appropriate by Installer.

(It is your responsibility to ensure that the existing surface is suitable to receive the appropriate fixing)



5. Beaters can be fixed to Stainless Steel posts with fixings provided

5. Make sure all fixings are covered and secure using cover caps provided

6. Beaters can be fixed to Steel posts with fixings provided

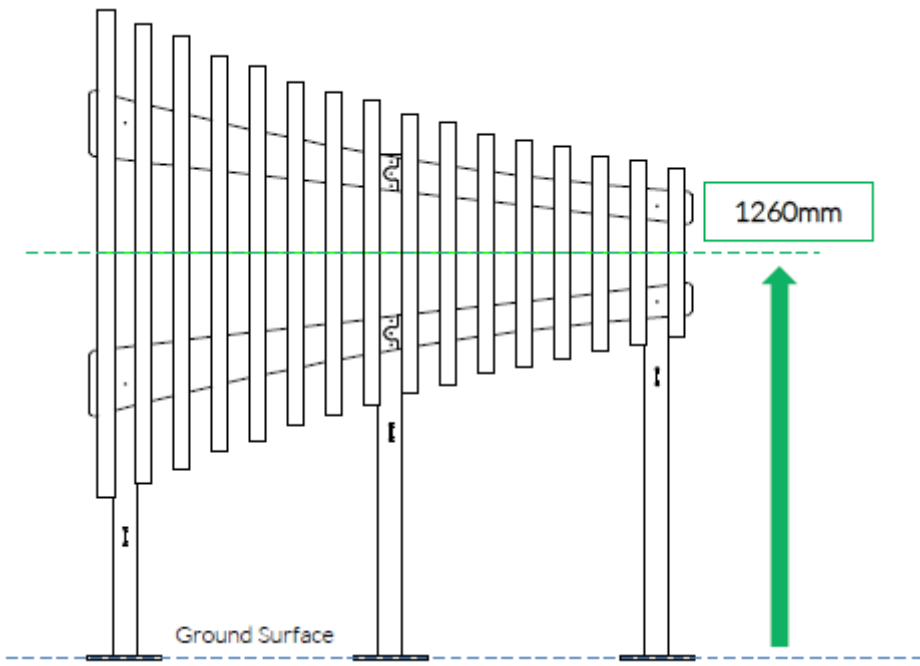

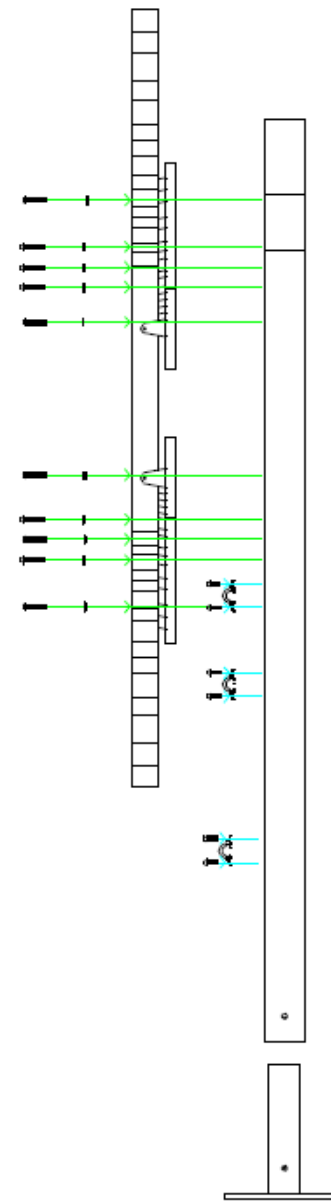
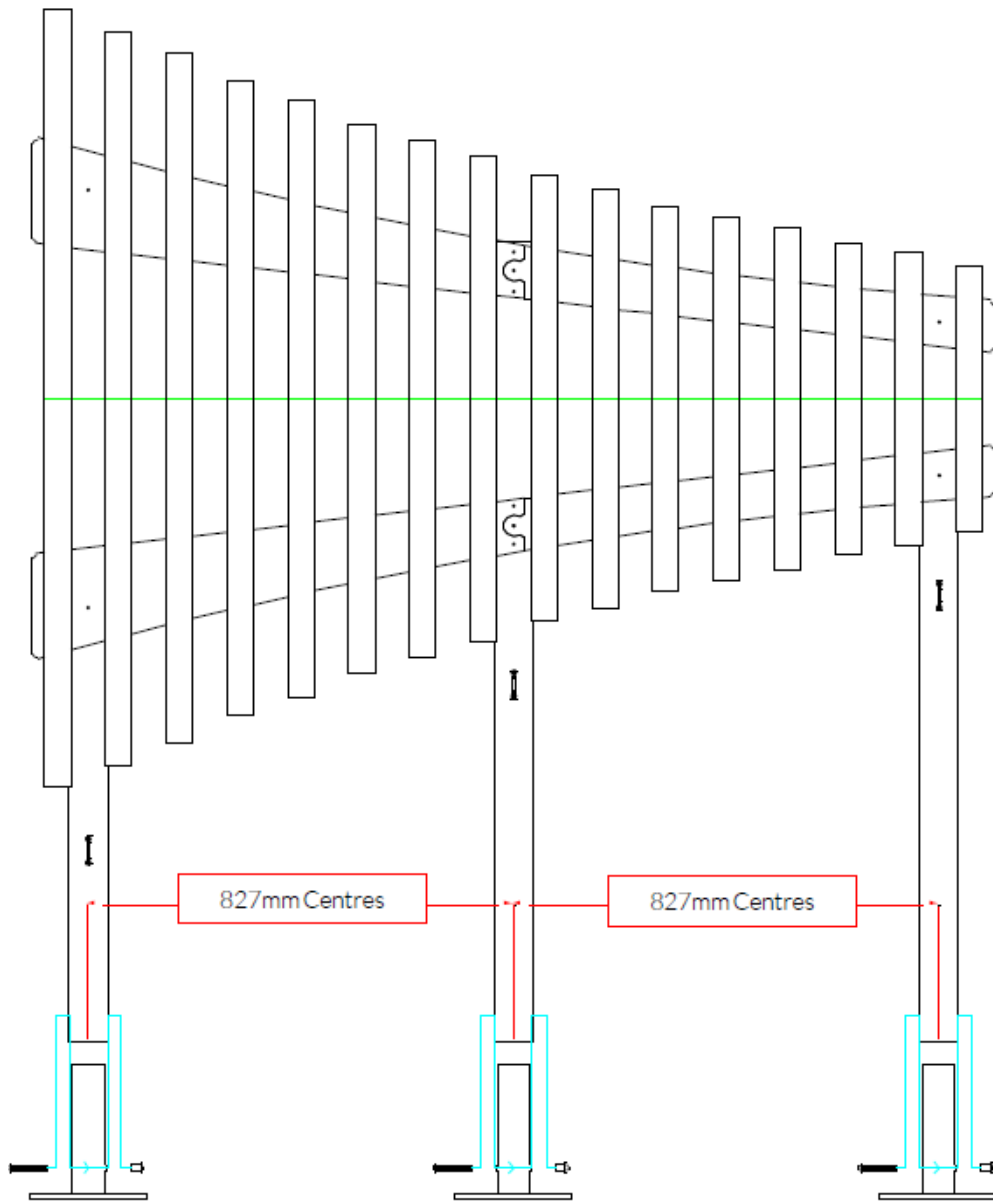

Tools:

x1 TX 40 Driver Bit

x1 TX 30 Driver Bit

COMPONENTS LIST:

-  Saddle Strap X3
-  M6x20 Pin torx X6
-  M8 Lock washer X10
-  M8x40 Pin torx X10
-  M10x70 Pin torx X3
-  M10 Barrel Nut Pin torx X3

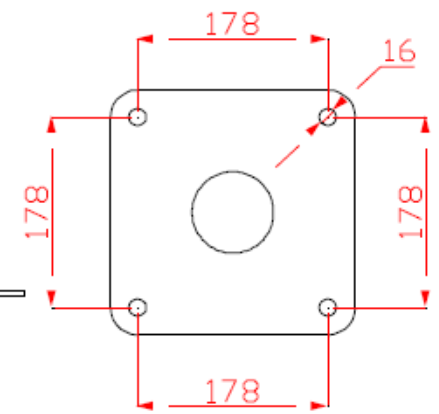

Surface Fix Post Installation

Components:



M10 Barrel Nut



M10x70 Security Screw



2 Part Cover Cap

Thread Lock Solution
Required (Not Supplied)

1

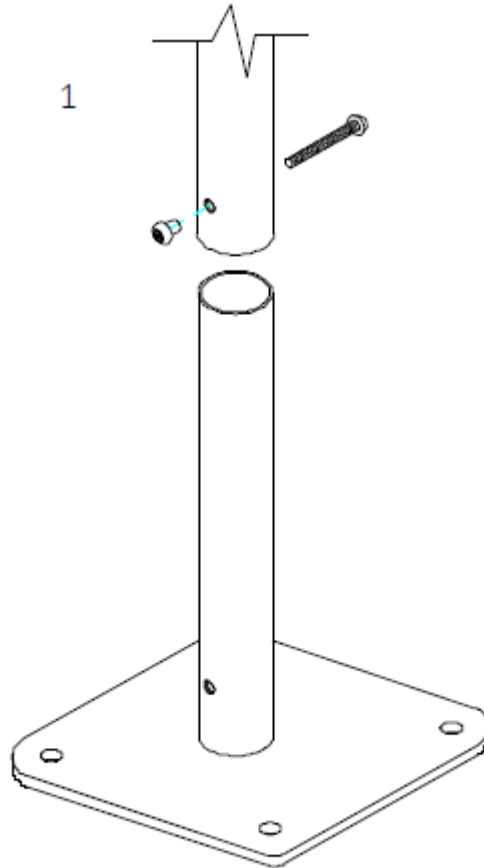

Locate the Surface fix Plate into the leg of the instrument.

2

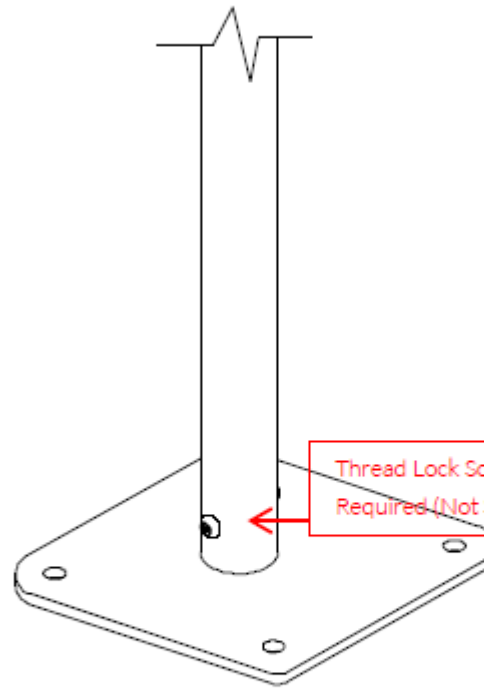

Fix instrument to Surface fix plate using M10 bolt and Barrel Nut and use **thread locking solution** to prevent fixings working loose.

3

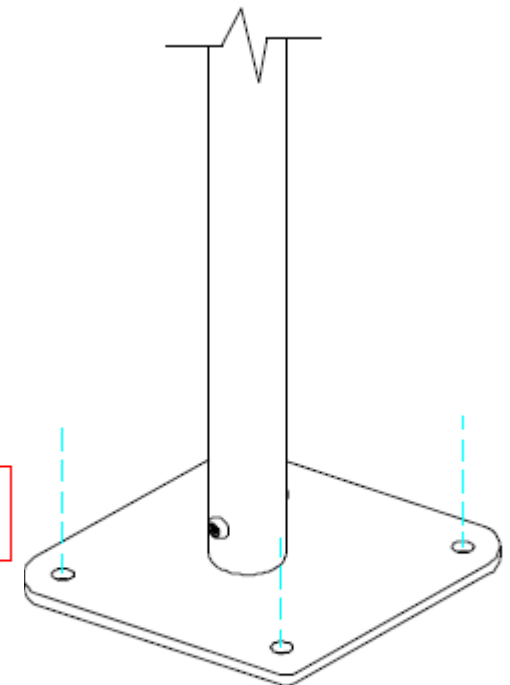
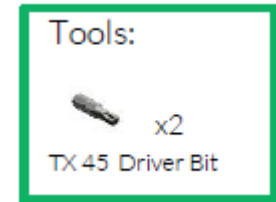

Fix Surface Plate to the ground surface **Ground Anchors Not provided** cover fixings with caps provided

Care & Maintenance

- Establish a schedule for regularly checking your outdoor musical instrument. Regularly inspect them and maintain them accordingly.
- Failure to adequately care for and maintain your products can affect the warranty.
- Do not alter or modify the product in such a way that the essential safety or sound of the product will be affected. Alterations and modifications may affect the warranty.
- Contact ROMPA® should spare parts or additional beaters be required.
- Contact ROMPA® should any repair or replacement be necessary.

Aluminium Notes

Aluminium notes have an anodic coating that can't be peeled off or flake away.

Keep the notes clean with soapy water or a mild detergent solution followed by rinsing with clean cold water.

After drying, a good household wax spray polish can be used.

Grease and dirt deposits may be removed by using solvents such as white spirit in conjunction with a soft cloth or soft bristle brush.

Never use harsh abrasives to clean the notes.

As the notes are permanently exposed to some atmospheric weathering, they should be regularly cleaned – not less than four times a year.

Steel Leg

Keep clean to ensure longevity.

Wipe clean with a mild detergent and rinse with clean cold water.

All cleaning solutions including acide based (exceptic hydrochloric acid) are suitable, as long as thoroughly rinsed with clean water afterwards.

Stainless steel polish can be used should you wish to cover any blemishes which may be causedd over the years, either by misuse or accidental damage.

Stainless steel is very low maintenance but in external areas it is recommended to be checked for blemishes or surface scratches.

Plastic Back Board (HPDE)

UV stable plastic is extremely low miantenance. Wipe clean with a mild detergent and rinse with clean cold water.

EN1176 Requirements (applies to Children's Playground Equipment)

All children's playground equipment is subject to regular inspections and maintenance works.

Maintain your outdoor musical instruments according to the instructions supplied with the product to look after the product and to adhere to the warranty requirements.

Excerpt from EN 1176-7:

Section 7 - Inspection schedule

7.1. To avoid accidents, the operator has to make sure that an adequate inspection schedule is developed and adhered to for each playground. In such a schedule, all local conditions and manufacturer's indications that may have an influence on the necessary maintenance frequency, have to be taken into consideration.

The inspection schedule should list all parts, which have to be checked during the different inspections, and the inspection procedures.

7.2. If severe and safety-endangering defects are discovered during an inspection, they should be eliminated immediately. If they cannot be repaired or replaced at once, the respective equipment has to be excluded from use, e.g. by dismantling or closing it down. If an equipment component has to be removed, e.g. for maintenance works, all anchoring or foundations that remain in the ground have to be removed also or be made inaccessible by means of covers. The construction site should then be secured.

As stated in the standards, we recommend a weekly 'Routine Visual Inspection' of your playground. In cases of heavily used or high-risk (e.g. vandalism) playgrounds or if the age of the equipment requires more frequent checks, you may want to increase the frequency of these inspections to daily. An 'Operational Inspection' should be carried out every month and after 12 months at the latest you are required to carry out an 'Annual Inspection' (for best effect this should be completed after the winter months).

Records should be kept alongside these instructions of all actions taken as part of safety management. On the last pages of these maintenance instructions you are offered a Maintenance Record Sheet for the entry of your maintenance report results.

Daily/Weekly Visual Routine Inspection

The routine maintenance of your outdoor musical instruments consists of preventative measures to maintain their level of safety and performance. On a 'Daily/Weekly Visual Routine Inspection' check for visible damage and loose parts:

- Are there any exposed foundations?
- Can you see sharp edges, broken, frayed or missing parts?
- Are components overly worn and torn?

Daily inspection is recommended for heavily-used or high-vandal-risk playgrounds or those that have already been in service for a certain period of time. Deal with all damages and defects as soon as these are found. Record all findings in the Maintenance Record Sheet (below).

Monthly Operational Inspection

As for the Weekly Visual Routine Inspection, the following checks have to be carried out during the Monthly Operational Inspection:

- Are there any exposed foundations?
- Can you see sharp edges, broken, frayed or missing parts?
- Are components overly worn and torn?

The 'Monthly Operational Inspection' requires the following supplementary checks:

- Are all metal parts well connected and not worn down?
- Are all screwed connections and bolted joints tight? If not, please tighten them.
- Are all plastic and or/rubber components satisfactory?

Deal with all damages and defects as soon as these are found. Record all findings in the Maintenance Record Sheet (below).

Annual Inspection

Carry out the 'Annual Inspection' after the winter or at least after 12 months. As well as the checks described above (Daily, Weekly, Monthly), the following checks are required:

- Are all foundations stable and the equipment well anchored?
- Replace joints that show severe corrosions or heavy wear and tear

Deal with all damages and defects as soon as these are found. Record all findings in the Maintenance Record Sheet (below). Copy the sheet or create your own for ongoing maintenance reporting.

Date of Inspection	Inspection (Daily/ Weekly/ Monthly /Annual)	Name of Inspector	Name of Instrument Inspected	Details of Defect Found	Action Taken	Date Defect Resolved